

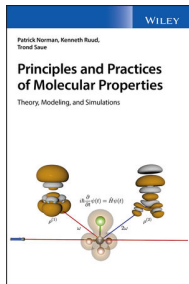

# Light–Matter Interactions

## Exact State Response Theory



Patrick Norman

Department of Theoretical Chemistry and Biology  
School of Engineering Sciences in Chemistry, Biotechnology and Health  
KTH Royal Institute of Technology  
Stockholm, Sweden

*A perspective on nonresonant and resonant electronic response theory for time-dependent molecular properties*

P. Norman, Phys. Chem. Chem. Phys. **13**, 20519 (2011)

## Dalton2018

```
**DALTON INPUT
.RUN RESPONSE
**WAVE FUNCTION
.DFT
B3LYP
**RESPONSE
*LINEAR
.DIPLN
.SINGLE RESIDUE
.ROOTS
10
*END OF INPUT
```

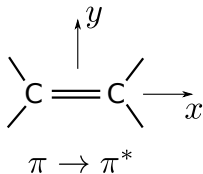

$$\lambda = 168 \text{ nm}$$

$$f = 0.33$$

## Gaussian16

```
#p TD=(nstates=10) B3LYP
```

```
ethylene
```

```
0 1
C 0.6680 0.0000 0.0000
C -0.6680 0.0000 0.0000
H 1.2437 0.9222 0.0000
H -1.2437 0.9222 0.0000
H 1.2437 -0.9222 0.0000
H -1.2437 -0.9222 0.0000
```

```
End of input
```

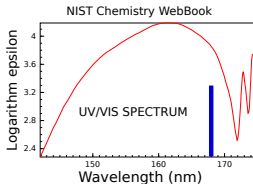

# General Frame of Reference

- ▶ In a simplistic and generalized view of spectroscopy, the observable is the number of detected particles (e.g. photons or electrons) per unit time in a narrow energy interval and into a small solid angle
- ▶ The observable is recorded under certain conditions regarding parameters such as temperature, pressure, concentration, and there exist a model (or connection) from which one can deduce molecular properties from the set of measured data
- ▶ Under typical circumstances in molecular spectroscopies, these connections can be viewed upon as measures of changes in an observable due to the presence of electromagnetic fields with origins attributed to external sources
- ▶ Compared to atomic fields, the electric fields of conventional lasers are relatively weak. A laser delivering pulses of 10 ns duration and 1 mJ in energy and with a spot size of 100  $\mu\text{m}$  produces an intensity of about 0.3 GW/cm<sup>2</sup>. This intensity corresponds to an electric field amplitude of some  $F^\omega = 5 \times 10^{-5}$  a.u., which is several orders of magnitude smaller than the internal electric fields that bind electrons in atomic and molecular systems

# Reasons to employ Perturbation Theory

Why do we not simply time propagate the Schrödinger equation in a direct and nonperturbational manner?

- ▶ The response functions defined in perturbation theory provide the natural meeting point between experiment and theory with a distinct separation of one-, two-, three-photon, etc., optical processes
- ▶ Error control is difficult to achieve as the accuracy depends on the propagation scheme, time length, and time step
- ▶ It is a numerically elaborate process to separate out nonlinearities from dominant lower-order components in the polarization
- ▶ Calculation of vibrational contributions can hardly be made practical in a nonperturbational approach.

# Response Theory and Perturbation Theory

Response theory may be thought of as a reformulation of standard time-dependent perturbation theory into a form suitable for approximate state theory.

Virtually all spectroscopic properties are encompassed by the theory.

Possible perturbations are:

- ▶ time-independent or time-dependent
- ▶ electric or magnetic
- ▶ internal or external
- ▶ geometric distortions

# Selection of molecular properties

## Electric

- ▶ Polarizability
- ▶ Hyperpolarizabilities

## Magnetic

- ▶ Magnetizability

## Electric–Magnetic

- ▶ Optical rotation
- ▶ Circular dichroism
- ▶ Faraday rotation
- ▶ Magnetic circular dichroism

## Electric–Geometric

- ▶ IR intensities
- ▶ Raman intensities
- ▶ Vibrational polarizabilities
- ▶ ZPVA polarizabilities

## Internal fields

- ▶  $g$ -tensor
- ▶ Fine-structure
- ▶ Spin-spin coupling
- ▶ Shieldings

# Historical Background

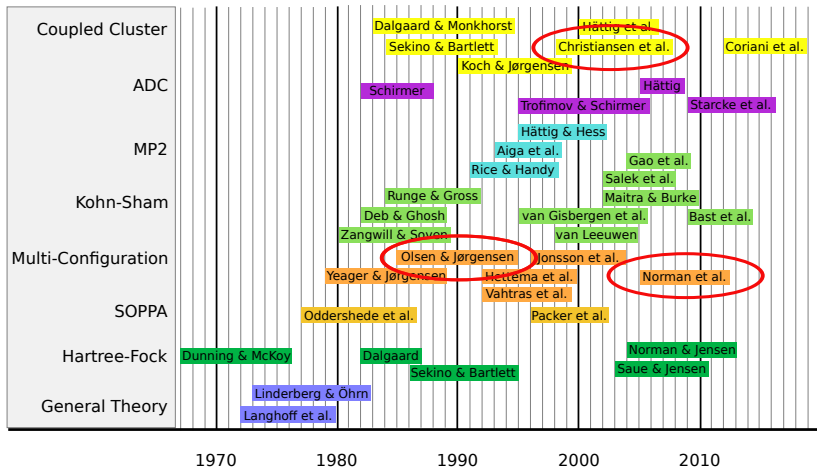

## A few selected motivations for derivation of exact-state response functions

- ▶ The formulations of quantum mechanics and perturbation theory that are suitable for approximate state theories are best illustrated in exact state theory
- ▶ It reveals the dependence of molecular response properties on intrinsic properties of the system, such as excitation energies and transition moments, and it thereby connects different spectroscopies
- ▶ It reveals general properties and symmetries of response functions that are also valid in approximate state theories
- ▶ It suggests the identification of excited state properties from a study of poles and residues of *ground state* response functions, e.g., excitation energies are identified as poles of linear response functions



# The Schrödinger equation and time dependence

The Schrödinger equation reads as

$$i\hbar \frac{\partial}{\partial t} \psi(t) = \hat{H}(t) \psi(t).$$

The *time-independent* Schrödinger equation reads as

$$\begin{aligned} \hat{H}_0 \psi_n(x) &= E_n \psi_n(x), \\ \psi(t) &= \psi_n(x) e^{-iE_n t / \hbar}. \end{aligned}$$

The wave function  $\psi(t)$  is *always* time-dependent, but for a stationary state the probability density is time-independent.

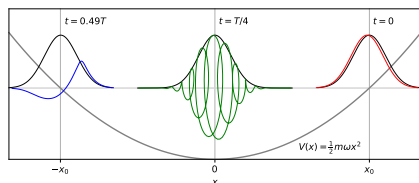

## Time-evolution for conservative systems: $\hat{H}(t) = \hat{H}_0$

The evolution of the wave function from some initial time  $t_0$  to time  $t$  is given by

$$\psi(t) = \hat{U}(t, t_0)\psi(t_0),$$

where

$$\hat{U}(t, t_0) = e^{-i\hat{H}_0(t-t_0)/\hbar}.$$

The operator  $\hat{U}(t, t_0)$  is referred to as the time evolution operator, or time propagator.

Note:

For cases when the Hamiltonian is time-dependent, a time propagator cannot be constructed in such a simple manner.

## Molecular properties from the “exact” wave function

We will now study a simple system for which we, for an arbitrary external electric field turned on at  $t = 0$ , will have access to the *exact* time-dependent wave function that solves the Schrödinger equation.

By exact, we mean “for all practical purposes exact” and limited only by the numerical representation on the computer, but this aspect is a side-issue to the present discussion.

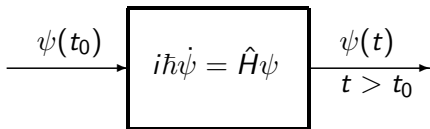

This toolbox will let us explore the different formulations of the theory of molecular properties without relying on perturbation theory.

## Two-level atom in static electric field (conservative system)

In the electric dipole approximation, the Hamiltonian of the system will equal

$$\hat{H} = \hat{H}_0 - \hat{\mu}F^0$$

where  $\hat{H}_0$  is the Hamiltonian of the isolated atom,  $\hat{\mu}$  is the electric dipole operator, and  $F^0$  is the amplitude of the external static electric field.

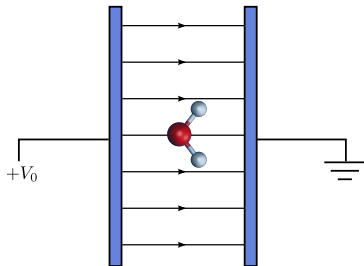

$$\begin{array}{l} E \uparrow \\ \Delta E = E_b - E_a \\ E_b \text{ ————— } \psi_b \\ E_a \text{ ————— } \psi_a \end{array} \quad \hat{H}_0 = \begin{bmatrix} E_a & 0 \\ 0 & E_b \end{bmatrix} \quad \hat{\mu} = \begin{bmatrix} 0 & \mu_{ab} \\ \mu_{ba} & 0 \end{bmatrix}$$

The energies of the ground and excited states are given as the eigenvalues of the Hamiltonian:

$$\det \left( \hat{H} - \hbar\omega \hat{I} \right) = 0$$

The two eigenvalues become

$$\hbar\omega = \frac{E_a + E_b}{2} \pm \sqrt{\frac{(E_b - E_a)^2}{4} + (\mu_{ab}F^0)^2}$$

from which, for small fields, the electric-field dependent energies are found to be

$$E'_a(F^0) = E_a - \frac{(\mu_{ab}F^0)^2}{\Delta E} + \frac{(\mu_{ab}F^0)^4}{(\Delta E)^3} + \dots$$
$$E'_b(F^0) = E_b + \frac{(\mu_{ab}F^0)^2}{\Delta E} - \frac{(\mu_{ab}F^0)^4}{(\Delta E)^3} + \dots$$

From these energy expansions we readily determine the electric polarization properties by taking the field derivatives of the energy in the limit of zero field strength. For the ground state, we get

$$\begin{aligned}\mu_a &= - \left. \frac{\partial E'_a}{\partial F^0} \right|_{F^0=0} = 0 \\ \alpha_a &= - \left. \frac{\partial^2 E'_a}{\partial (F^0)^2} \right|_{F^0=0} = 2 \frac{(\mu_{ab})^2}{\Delta E} \\ \beta_a &= - \left. \frac{\partial^3 E'_a}{\partial (F^0)^3} \right|_{F^0=0} = 0 \\ \gamma_a &= - \left. \frac{\partial^4 E'_a}{\partial (F^0)^4} \right|_{F^0=0} = -24 \frac{(\mu_{ab})^4}{(\Delta E)^3}\end{aligned}$$

where we have introduced the electric dipole moment ( $\mu$ ), polarizability ( $\alpha$ ), first-order hyperpolarizability ( $\beta$ ), and second-order hyperpolarizability ( $\gamma$ ).

## Two-level atom in optical field (nonconservative system)

In the electric dipole approximation, the Hamiltonian of the system will equal

$$\hat{H}(t) = \hat{H}_0 - \hat{\mu}F(t)$$

where  $\hat{H}_0$  is the Hamiltonian of the isolated atom,  $\hat{\mu}$  is the electric dipole operator, and  $F(t)$  is the external electric field.

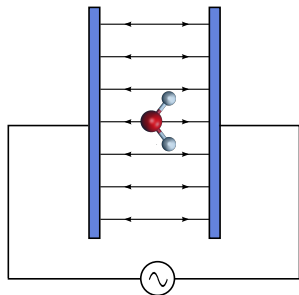

$$\begin{array}{l} E \uparrow \\ \Delta E = E_b - E_a \\ E_b \text{ ————— } \psi_b \\ E_a \text{ ————— } \psi_a \end{array} \quad \hat{H}_0 = \begin{bmatrix} E_a & 0 \\ 0 & E_b \end{bmatrix} \quad \hat{\mu} = \begin{bmatrix} 0 & \mu_{ab} \\ \mu_{ba} & 0 \end{bmatrix}$$

## Nonconservative system: Study of Induced Dipole Moment

By  $\psi(t)$  we will denote the time-dependent wave function that is a solution to the Schrödinger equation

$$i\hbar \frac{\partial}{\partial t} \psi(t) = \hat{H} \psi(t).$$

We will assume that a nonresonant ( $\omega = 0.1$  a.u.) external perturbation is slowly switched on ( $a = 1/100$  a.u.) in accordance with

$$F(t) = F^\omega \sin \omega t \times \text{erf}(at).$$

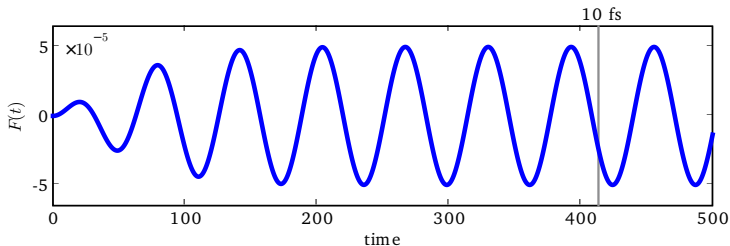



## Initial Condition

The initial condition for our system is that it resides in the ground state prior to exposure of the perturbation and with a phase that is zero at  $t = 0$ , i.e.

$$\psi(t) = \psi_a e^{-iE_a t/\hbar} \quad \text{for } t \leq 0$$

## Infinitesimal Time Propagation

With a time step  $\Delta t$  that is small, we can consider the external field to be constant between  $t_0$  and  $t_0 + \Delta t$  and thereby get

$$\psi(t_0 + \Delta t) = \hat{U}(t_0, t_0 + \Delta t)\psi(t_0)$$

where the time-evolution propagator equals

$$\hat{U}(t_0, t_0 + \Delta t) = e^{-i\hat{H}(t_0)\Delta t/\hbar}$$

## Time Propagation

Repeated application of  $\hat{U}$  enables us to determine the wave function in the region  $t > 0$ , and, given the time-dependent wave function, the dipole moment is obtained as the expectation value of the electric dipole operator according to

$$\mu(t) = \langle \psi(t) | \hat{\mu} | \psi(t) \rangle$$

### Initialization

```
psi[:,0]=[1, 0]
H=array([[Ea, 0],
        [0, Eb]])
mu=array([[0, muab],
         [muba, 0]])
F=Fw*sin(w*t)*erf
```

### Time propagation

```
for k in range(1,n):
    psi[:,k]=dot(expm(-1j*(H-mu*F[k-1])*delta),psi[:,k-1])
    P[k]=dot(conj(psi[:,k]),dot(mu,psi[:,k]))
```

## Populations of States

As a measure of the effect of the perturbation on the system, we may study the population in the ground and excited states which we denote by  $\rho_a(t)$  and  $\rho_b(t)$ , respectively. The populations are given by the projections of the wave function on the eigenfunctions of  $\hat{H}_0$  according to

$$\rho_a(t) = |\langle \psi_a | \psi(t) \rangle|^2 \quad \rho_b(t) = |\langle \psi_b | \psi(t) \rangle|^2$$

## Program code

```
popa=conj(psi[0,:])*psi[0,:]
popb=conj(psi[1,:])*psi[1,:]
```

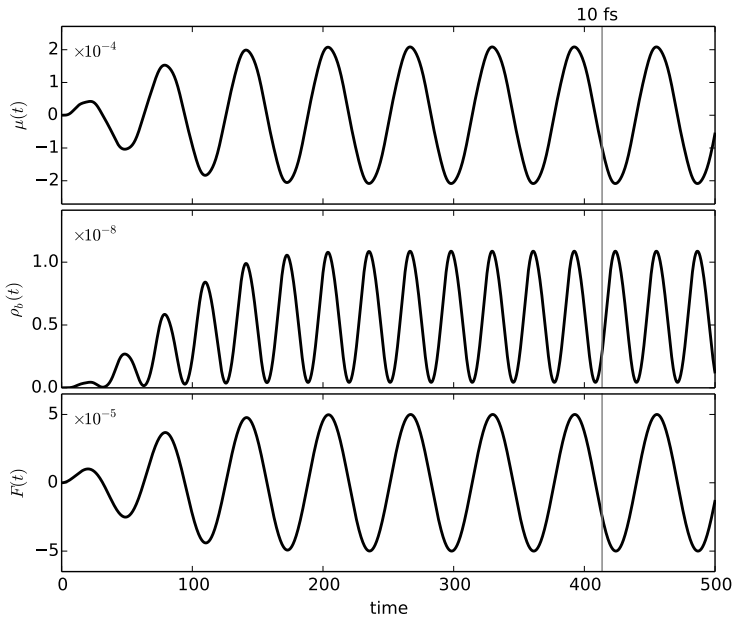

## Induced Dipole Moment

Molecular properties are defined by an expansion of the induced dipole moment in orders the time-dependent electric field

$$\mu(t) = \alpha F(t) + \frac{1}{6}\gamma F^3(t) + \dots$$

## Polarizability

The linear polarizability can be read off directly as the ratio of the amplitudes of the polarization and the electric field

$$\alpha = \frac{\max[\mu(t)]}{F\omega} \approx 4.17 \text{ a.u.}$$

## Dispersion

The dependency of the molecular property (in this case the polarizability) to the frequency of the perturbation is referred to as the *dispersion* of the property.

## Dispersion and Rayleigh scattering: practical example

A clear cloudless day-time sky is blue because molecules in the air scatter blue light from the sun more than they scatter red light. When we look towards the sun at sunset, we see red and orange colors because the blue light has been scattered out and away from the line of sight.

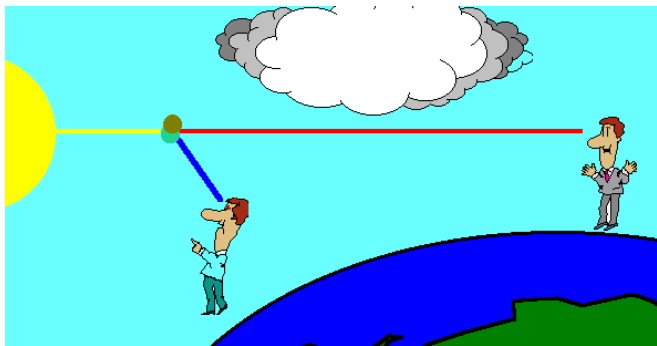

Source: [http://math.ucr.edu/home/baez/physics/General/BlueSky/blue\\_sky.html](http://math.ucr.edu/home/baez/physics/General/BlueSky/blue_sky.html)

## Where are the nonlinearities?

$$\mu(t) = \alpha F(t) + \frac{1}{6}\gamma F^3(t) + \dots$$

There are three ways to enhance nonlinear responses:

- ▶ Design system with large  $\gamma$ -value
- ▶ Increase the electric field strength
- ▶ Tune the frequency to multi-photon resonances

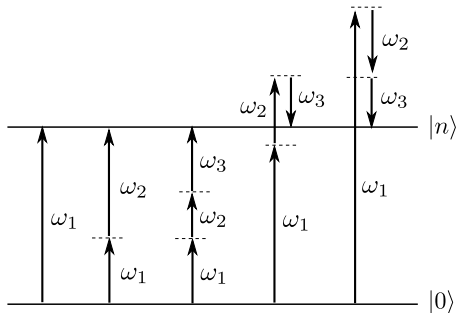

## Nonlinear responses

Choose:  $F^\omega = 0.02$  a.u. and  $\omega = 0.166$  a.u.:

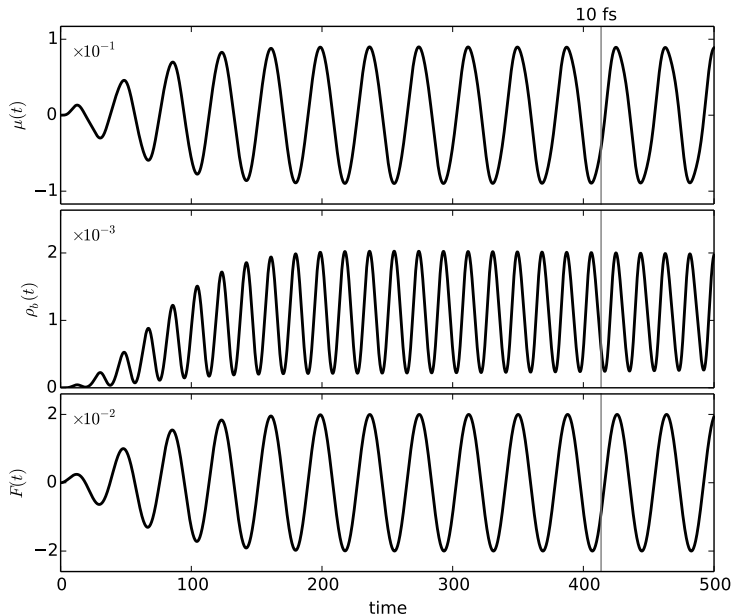



# Fourier transform of response signal

$$\mu(t) = \alpha(-\omega; \omega) F^\omega \sin(\omega t) + \frac{1}{6} \gamma(-3\omega; \omega, \omega, \omega) F^\omega F^\omega F^\omega \sin(3\omega t) + \dots$$

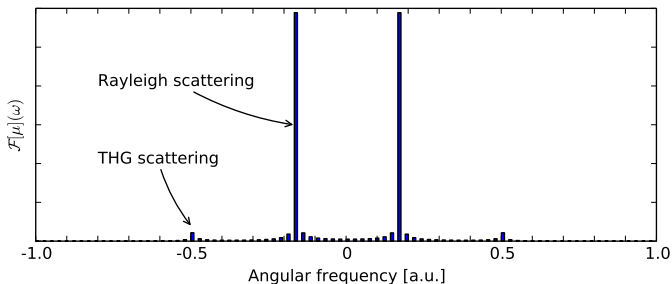
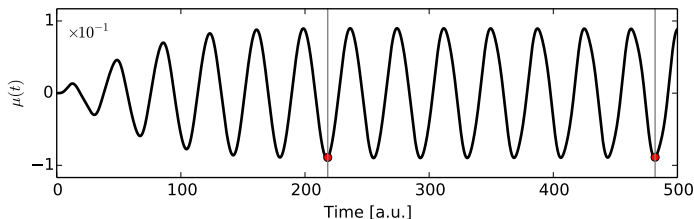

## Nonlinear responses: practical example

A robust fiber-coupled PPLN frequency-conversion waveguide device is suitable for use with fiber-based frequency combs and spectroscopy. The device shown is designed to accept a supercontinuum light source in the 2000 nm region and outputs a frequency-doubled signal centered at 1064 nm.

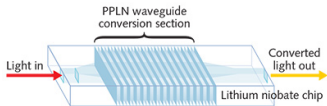
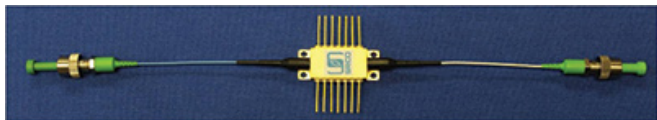

Source: <http://www.laserfocusworld.com/>

## Nonconservative system: expectation value summary

- ▶ The energy of the system is not well defined as energy transfer occurs between field and system
- ▶ The dipole moment and other observables (expectation values) are well defined and time-dependent
- ▶ Molecular properties (response functions) are defined as expansion coefficients of the observable in terms of field strengths
- ▶ The overall phase of the wave function is of no concern
- ▶ Linear response functions are directly identified as ratios of induced dipole moments and field strengths (in the small field limit)
- ▶ Nonlinear response functions can be obtained in the same manner but the procedure is hampered by numerical issues

## Nonconservative system: Study of quasi-energy

We write the wave function  $\psi(t)$  as the product of two time-dependent functions in the following manner

$$\psi(t) = e^{-i\phi(t)}\bar{\psi}(t)$$

This division is made unique by requiring that  $\phi(t)$  is a real function (a phase) and that the phase of the projection of  $\bar{\psi}(t)$  onto  $\psi_a$  is zero.

In absence of the external field, the wave function becomes equal to

$$\psi(t) = \psi_a e^{-iE_a t/\hbar}$$

and the two requirements on  $\phi(t)$  and  $\bar{\psi}(t)$  lead to the division

$$\bar{\psi}(t) = \psi_a \quad \phi(t) = E_a t/\hbar$$

This is the reason why  $\bar{\psi}(t)$  is referred to as the phase isolated wave function.

## Equation of motion for phase-isolated wave function

We substitute the product function into the Schrödinger equation to arrive at

$$\left( \hat{H} - i\hbar \frac{\partial}{\partial t} \right) \bar{\psi}(t) = Q(t) \bar{\psi}(t)$$

where  $Q(t)$ , which is known as the time-dependent quasi-energy, has been introduced for the time derivative of the phase function, i.e.,

$$Q(t) = \hbar \dot{\phi}(t)$$

It is clear that, given  $Q(t)$ , the phase function  $\phi(t)$  is obtained by time integration according to

$$\phi(t) = \frac{1}{\hbar} \int^t Q(t') dt'$$

We obtain two coupled differential equations

$$Q(t) = \langle \bar{\psi} | \left( \hat{H} - i\hbar \frac{\partial}{\partial t} \right) | \bar{\psi} \rangle$$

and

$$\langle \bar{\psi}_\perp | \left( \hat{H} - i\hbar \frac{\partial}{\partial t} \right) | \bar{\psi} \rangle = 0.$$

As orthogonal complement vector, we may choose

$$\bar{\psi}_\perp(t) = \psi_b - b^*(t) \psi_a,$$

and, we arrive at

$$\hbar \dot{b}(t) = -i\Delta E b(t) + i\mu_{ab} F(t)[1 - b^2(t)].$$

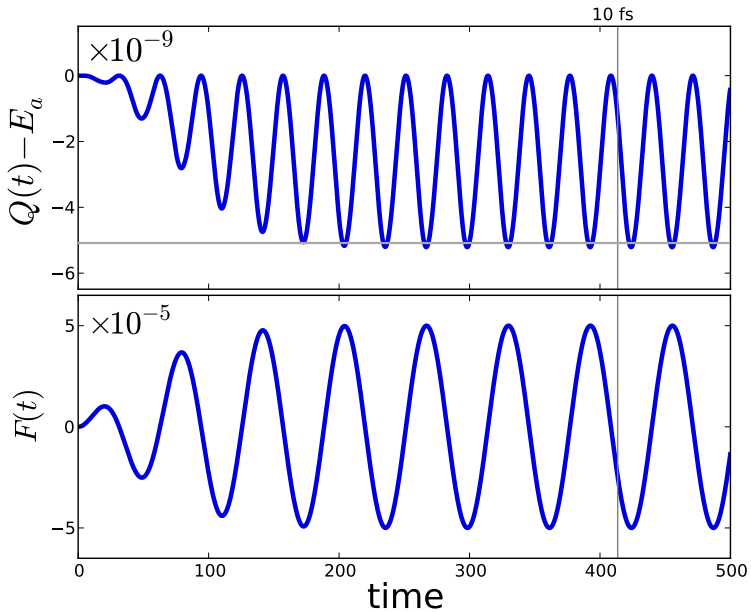

## Variations of the wave function

The square norm of the wave function is a functional

$$N[\psi] = \int \psi^* \psi \, d\tau = \langle \psi | \psi \rangle$$

The first variation of  $N$  is

$$\begin{aligned} \delta N &= \left. \frac{d}{d\varepsilon} N[\psi + \varepsilon \delta\psi] \right|_{\varepsilon=0} = \left. \frac{d}{d\varepsilon} \int (\psi + \varepsilon \delta\psi)^* (\psi + \varepsilon \delta\psi) \, d\tau \right|_{\varepsilon=0} \\ &= \int (\delta\psi^* \psi + \psi^* \delta\psi) \, d\tau = \langle \delta\psi | \psi \rangle + \langle \psi | \delta\psi \rangle \end{aligned}$$

Since  $\delta N$  must be zero, we have that variations in the wave function must fulfill

$$\delta\psi(\mathbf{t}) = \delta\psi_{\perp} + \delta\psi_{\parallel}; \quad \delta\psi_{\parallel} = i\epsilon(\mathbf{t})\psi; \quad \epsilon(\mathbf{t}) \in \mathcal{R}$$



## Allowed variations in phase isolated wave functions

Since  $\bar{\psi}$  and  $\psi$  differ by a mere overall phase factor, we have

$$N[\bar{\psi}] = \langle \bar{\psi} | \bar{\psi} \rangle = \langle \psi | \psi \rangle = 1$$

and, since,

$$\frac{dN}{dF\omega} = \left\langle \frac{d\bar{\psi}}{dF\omega} \middle| \bar{\psi} \right\rangle + \langle \bar{\psi} \middle| \frac{d\bar{\psi}}{dF\omega} \rangle = 0$$

we conclude that

$$\delta\bar{\psi}(t) = \frac{d\bar{\psi}}{dF\omega}$$

is an allowed variation.

## First variation of the energy

The energy associated with a time-independent wave function is a functional

$$E[\psi] = \int \psi^* \hat{H} \psi d\tau = \langle \psi | \hat{H} | \psi \rangle$$

At points  $\psi = \psi_n$  with  $\hat{H}\psi_n = E_n\psi_n$ , the first variation of  $E$  is

$$\begin{aligned} \delta E &= \left. \frac{d}{d\varepsilon} E[\psi_n + \varepsilon\delta\psi] \right|_{\varepsilon=0} = \left. \frac{d}{d\varepsilon} \int (\psi_n + \varepsilon\delta\psi)^* \hat{H} (\psi_n + \varepsilon\delta\psi) d\tau \right|_{\varepsilon=0} \\ &= E_n \int (\delta\psi^* \psi_n + \psi_n^* \delta\psi) d\tau = E_n \delta N = 0 \end{aligned}$$

As a consequence for a system in a static field  $F^0$ , we get

$$\frac{dE}{dF^0} = \langle \psi_n | \frac{\partial \hat{H}}{\partial F^0} | \psi_n \rangle + \delta E = -\langle \psi_n | \hat{\mu} | \psi_n \rangle$$

which is known as the Hellmann–Feynman theorem.

## First variation of the quasi-energy

The quasi-energy

$$Q(t) = \langle \bar{\psi} | \left( \hat{H} - i\hbar \frac{\partial}{\partial t} \right) | \bar{\psi} \rangle$$

is a functional that depends on  $\bar{\psi}$ .

It is real since

$$\begin{aligned} Q(t) &= \langle \bar{\psi} | \left( \hat{H} - i\hbar \frac{\partial}{\partial t} \right) | \bar{\psi} \rangle \\ &= \langle \bar{\psi} | \left( \hat{H} - i\hbar \frac{\partial}{\partial t} \right) | \bar{\psi} \rangle^* - i\hbar \frac{\partial}{\partial t} \langle \bar{\psi} | \bar{\psi} \rangle \\ &= Q^*(t) \end{aligned}$$

The first variation of the quasi-energy becomes

$$\begin{aligned}\delta Q &= \langle \delta \bar{\psi} | \left( \hat{H} - i\hbar \frac{\partial}{\partial t} \right) | \bar{\psi} \rangle + \langle \bar{\psi} | \left( \hat{H} - i\hbar \frac{\partial}{\partial t} \right) | \delta \bar{\psi} \rangle \\ &= \langle \delta \bar{\psi} | \left( \hat{H} - i\hbar \frac{\partial}{\partial t} \right) | \bar{\psi} \rangle + \langle \delta \bar{\psi} | \left( \hat{H} - i\hbar \frac{\partial}{\partial t} \right) | \bar{\psi} \rangle^* - i\hbar \frac{\partial}{\partial t} \langle \bar{\psi} | \delta \bar{\psi} \rangle \\ &= Q(t) \left[ \langle \delta \bar{\psi} | \bar{\psi} \rangle + \langle \delta \bar{\psi} | \bar{\psi} \rangle^* \right] - i\hbar \frac{\partial}{\partial t} \langle \bar{\psi} | \delta \bar{\psi} \rangle \\ &= -i\hbar \frac{\partial}{\partial t} \langle \bar{\psi} | \delta \bar{\psi} \rangle = \hbar \frac{\partial \epsilon(t)}{\partial t}\end{aligned}$$

or

$$\delta Q(t) + i\hbar \frac{\partial}{\partial t} \langle \bar{\psi} | \delta \bar{\psi} \rangle = 0$$

which may be used as the starting point for the formulation of a time-dependent variational principle.

## Time-dependent Hellmann–Feynman theorem

We consider as an allowed variation

$$\delta\bar{\psi}(t) = \frac{d\bar{\psi}(t)}{dF\omega}$$

As a consequence, we get

$$\frac{dQ(t)}{dF\omega} = \langle\bar{\psi}|\frac{\partial\hat{H}}{\partial F\omega}|\bar{\psi}\rangle + \delta Q(t) = \langle\bar{\psi}|\frac{\partial\hat{H}}{\partial F\omega}|\bar{\psi}\rangle - i\hbar\frac{\partial}{\partial t}\langle\bar{\psi}|\frac{d\bar{\psi}}{dF\omega}\rangle$$

which is known as the time-dependent Hellmann–Feynman theorem.

To first order in the field strength  $F\omega$ , the last term vanishes in our simple example and we get

$$\frac{dQ(t)}{dF\omega} = \langle\bar{\psi}|\frac{\partial\hat{H}}{\partial F\omega}|\bar{\psi}\rangle = -\langle\bar{\psi}|\hat{\mu}|\bar{\psi}\rangle \sin\omega t \times \operatorname{erf}(at)$$

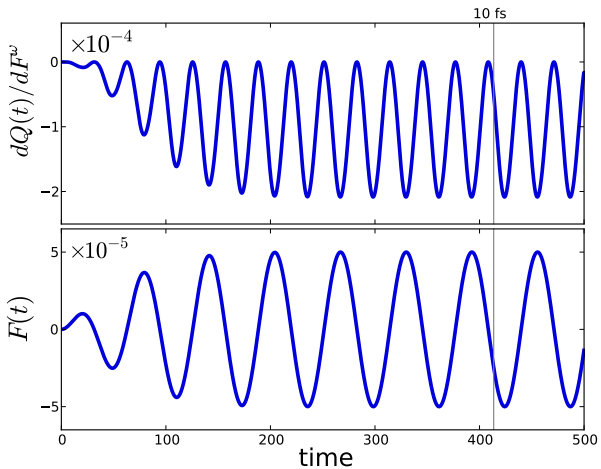

$$\alpha = -\frac{\min [dQ(t)/dF^\omega]}{F^\omega} \approx 4.17 \text{ a.u.}$$

## Time-averaged quasi-energy

Since

$$\frac{1}{T} \int_0^T \dot{f}(t) dt = 0$$

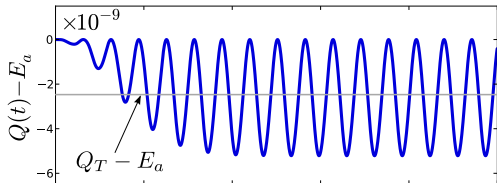

for any periodic function  $f(t)$  with period time  $T$ , we have for

$$Q_T = \frac{1}{T} \int_t^{t+T} Q(t') dt'$$

that the time-dependent variational principle reduces to

$$\delta Q_T = 0$$

The time-dependent Hellmann–Feynman theorem assumes the form

$$\frac{dQ_T}{dF\omega} = \frac{1}{T} \int_t^{t+T} \langle \bar{\psi}(t') | \frac{\partial \hat{H}}{\partial F\omega} | \bar{\psi}(t') \rangle dt'$$

## Nonconservative system: quasi-energy summary

- ▶ Based on the overall phase factor of the wave function we define a quantity known as the quasi-energy
- ▶ This quasi-energy is not an observable
- ▶ The formulation of a time-dependent Hellmann–Feynman theorem allows us to identify molecular properties (response functions) as the expansion coefficients of the time-averaged quasi-energy
- ▶ The quasi-energy technique becomes similar to energy derivative techniques in the time-independent case
- ▶ The quasi-energy approach allows for a common formulation of response theory for variational and non-variational wave function models



# Molecular properties from perturbation theory expansions of the wave function

Expansions are made in the basis of the exact eigenstates of the zeroth-order Hamiltonian

# The response theory cookbook recipe:

1. Find an efficient parameterization of wave function
  - ▶ redundancy
  - ▶ state vector normalization
  - ▶ phase isolation and secular divergences
2. Choose an appropriate equations-of-motion
  - ▶ based on Schrödinger equation
  - ▶ equivalent in exact state theory
  - ▶ important in approximate state theory
3. Apply perturbation theory
  - ▶ a lot of algebra
4. Form a well-defined quantity of interest, e.g.  $Q(t)$  or  $\mu(t)$ , and identify response functions

## Parametrization by projections

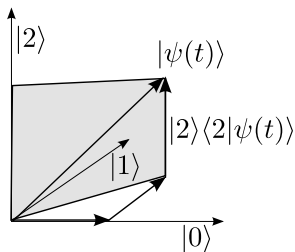

$$\psi(t) = \sum_n c_n(t) \psi_n; \quad c_n(t) = \langle n | \psi(t) \rangle$$

requires that

$$\sum_n |c_n(t)|^2 = 1.$$

## Parametrization by rotations

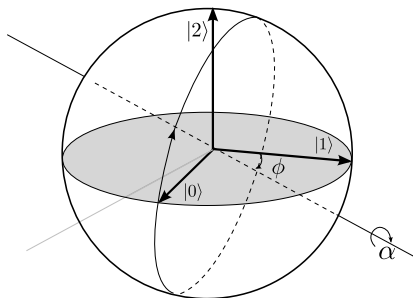

$$|\bar{\psi}(t)\rangle = e^{-i\hat{P}(t)}|0\rangle; \quad \hat{P}(t) = \sum_{n>0} \left[ P_n(t)|n\rangle\langle 0| + P_n^*(t)|0\rangle\langle n| \right]$$

$$e^{-i\hat{P}(t)}|0\rangle = |0\rangle \cos \alpha - i \sum_{n>0} P_n |n\rangle \frac{\sin \alpha}{\alpha}; \quad \alpha = \sqrt{\sum_{n>0} |P_n|^2}.$$

## Ehrenfest theorem

The time-change of an observable associated with a time-independent Hermitian operator  $\hat{\Omega}$  equals

$$\begin{aligned}\frac{d\Omega(t)}{dt} &= \frac{d}{dt} \langle \bar{\psi}(t) | \hat{\Omega} | \bar{\psi}(t) \rangle = \frac{d}{dt} \langle \psi(t) | \hat{\Omega} | \psi(t) \rangle \\ &= \langle \psi(t) | \hat{\Omega} | \frac{d\psi(t)}{dt} \rangle + \langle \frac{d\psi(t)}{dt} | \hat{\Omega} | \psi(t) \rangle \\ &= \frac{1}{i\hbar} \langle \psi(t) | [\hat{\Omega}, \hat{H}] | \psi(t) \rangle = \frac{1}{i\hbar} \langle \bar{\psi}(t) | [\hat{\Omega}, \hat{H}] | \bar{\psi}(t) \rangle\end{aligned}$$

where, in the intermediate step, we have used that  $\psi(t)$  is a solution to the Schrödinger equation.

This equation of motion is known as the Ehrenfest theorem.

## Liouville equation

The density operator for a *pure state* equals

$$\hat{\rho}(t) = |\psi(t)\rangle\langle\psi(t)| = |\bar{\psi}(t)\rangle\langle\bar{\psi}(t)|$$

Its time dependence obeys

$$\begin{aligned}\frac{d\hat{\rho}(t)}{dt} &= \left| \frac{d\psi(t)}{dt} \right\rangle \langle\psi(t)| + |\psi(t)\rangle \left\langle \frac{d\psi(t)}{dt} \right| \\ &= \frac{1}{i\hbar} [\hat{\rho}, \hat{H}]\end{aligned}$$

where, in the intermediate step, we have used that  $\psi(t)$  is a solution to the Schrödinger equation.

This equation of motion is known as the Liouville equation. It is readily extended to describe non-pure states and include relaxation processes.

# Choice of Equation of Motion

- ▶ Rayleigh–Schrödinger

$$i\hbar \frac{\partial}{\partial t} \psi(t) = \hat{H} \psi(t); \quad \psi(t) = \sum_n c_n(t) \psi_n$$

- ▶ Ehrenfest theorem

$$\frac{\partial}{\partial t} \langle \bar{\psi}(t) | \hat{\Omega} | \bar{\psi}(t) \rangle = \frac{1}{i\hbar} \langle \bar{\psi}(t) | [\hat{\Omega}, \hat{H}] | \bar{\psi}(t) \rangle$$

- ▶ Quasi-energy

$$Q(t) = \langle \bar{\psi} | \left( \hat{H} - i\hbar \frac{\partial}{\partial t} \right) | \bar{\psi} \rangle$$

- ▶ Liouville equation

$$\frac{\partial}{\partial t} \rho_{mn} = \frac{1}{i\hbar} [\hat{H}, \hat{\rho}]_{mn} - \gamma_{mn} (\rho_{mn} - \rho_{mn}^{\text{eq}})$$

## Perturbation theory

The Hamiltonian can be divided according to

$$\hat{H} = \hat{H}_0 + \hat{V}(t); \quad \hat{V}(t) = \sum_{\omega} \hat{V}^{\omega} F^{\omega} e^{-i\omega t} e^{\epsilon t}.$$

The solutions to the eigenvalue problem of  $\hat{H}_0$  are known:

$$\hat{H}_0 |n\rangle = E_n |n\rangle,$$

where  $|n\rangle$  are the exact eigenstates and  $E_n$  the respective energies. Before being exposed to the perturbation, we assume the molecule to be in a reference state  $|0\rangle$ —in most cases the molecular ground state—which corresponds to  $P_n(-\infty) = 0$  for all  $n > 0$ .



## Response Functions from the Polarization

The time-evolution of  $P_n(t)$  is determined from the Ehrenfest theorem applied to  $\hat{\Omega} = |0\rangle\langle n|$ :

$$\frac{\partial}{\partial t} \langle \bar{\psi}(t) | \hat{\Omega} | \bar{\psi}(t) \rangle = \frac{1}{i\hbar} \langle \bar{\psi}(t) | [\hat{\Omega}, \hat{H}_0 + \hat{V}(t)] | \bar{\psi}(t) \rangle.$$

Expansion is made with

$$e^{i\hat{P}(t)} \hat{\Omega} e^{-i\hat{P}(t)} = \hat{\Omega} + i[\hat{P}, \hat{\Omega}] - \frac{1}{2}[\hat{P}, [\hat{P}, \hat{\Omega}]] - \frac{i}{6}[\hat{P}, [\hat{P}, [\hat{P}, \hat{\Omega}]]] + \dots,$$

and

$$\begin{aligned} \langle 0 | [\hat{P}, \hat{\Omega}] | 0 \rangle &= -P_n, \\ \langle 0 | [\hat{P}, [\hat{P}, \hat{\Omega}]] | 0 \rangle &= 0, \\ \langle 0 | [\hat{P}, [\hat{P}, [\hat{P}, \hat{\Omega}]]] | 0 \rangle &= -4P_n \sum_{m>0} |P_m|^2. \end{aligned}$$

as well as

$$[\hat{\Omega}, \hat{H}_0] = \hbar\omega_{n0}\hat{\Omega}.$$

## Perturbation expansion

With

$$P_n(t) = P_n^{(1)} + P_n^{(2)} + P_n^{(3)} + \dots,$$

the first-order equation reads

$$\frac{\partial}{\partial t} \langle 0 | [\hat{P}^{(1)}, \hat{\Omega}] | 0 \rangle = \frac{1}{i\hbar} \langle 0 | [\hat{P}^{(1)}, [\hat{\Omega}, \hat{H}_0]] | 0 \rangle - \frac{1}{\hbar} \langle 0 | [\hat{\Omega}, \hat{V}(t)] | 0 \rangle.$$

or, equivalently,

$$\frac{\partial}{\partial t} P_n^{(1)} = -i\omega_{n0} P_n^{(1)} + \frac{1}{\hbar} \langle n | \hat{V}(t) | 0 \rangle,$$

which, by direct time-integration, yields

$$\begin{aligned} P_n^{(1)} &= e^{-i\omega_{n0}t} \int^t \frac{1}{\hbar} \langle n | \hat{V}(t') | 0 \rangle e^{i\omega_{n0}t'} dt' \\ &= \frac{1}{i\hbar} \sum_{\omega} \frac{\langle n | \hat{V}^{\omega} | 0 \rangle F^{\omega} e^{-i\omega t}}{\omega_{n0} - \omega}. \end{aligned}$$

## Linear response function

The response functions of the observable  $\hat{\Omega}$  are defined by:

$$\begin{aligned}\langle \bar{\psi}(t) | \hat{\Omega} | \bar{\psi}(t) \rangle &= \langle 0 | \hat{\Omega} | 0 \rangle + \sum_{\omega_1} \langle \langle \hat{\Omega}; \hat{V}^{\omega_1} \rangle \rangle F^{\omega_1} e^{-i\omega_1 t} \\ &+ \frac{1}{2} \sum_{\omega_1 \omega_2} \langle \langle \hat{\Omega}; \hat{V}^{\omega_1}, \hat{V}^{\omega_2} \rangle \rangle F^{\omega_1} F^{\omega_2} e^{-i(\omega_1 + \omega_2)t} + \dots\end{aligned}$$

We identify:

$$i \langle 0 | [\hat{P}^{(1)}, \hat{\Omega}] | 0 \rangle = \sum_{\omega} \langle \langle \hat{\Omega}; \hat{V}^{\omega} \rangle \rangle F^{\omega} e^{-i\omega t}$$

or, equivalently,

$$\langle \langle \hat{\Omega}; \hat{V}^{\omega} \rangle \rangle = -\frac{1}{\hbar} \sum_{n>0} \left[ \frac{\langle 0 | \hat{\Omega} | n \rangle \langle n | \hat{V}^{\omega} | 0 \rangle}{\omega_{n0} - \omega} + \frac{\langle 0 | \hat{V}^{\omega} | n \rangle \langle n | \hat{\Omega} | 0 \rangle}{\omega_{n0} + \omega} \right].$$

## Two-level atom: response function value

Observable:  $\hat{\Omega} = \hat{\mu}$

Perturbation:  $\hat{V}^\omega = -\hat{\mu}$

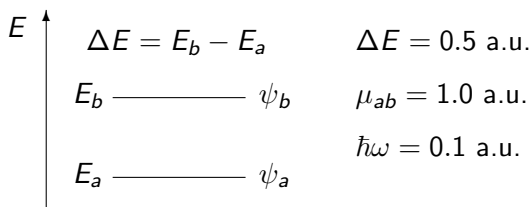

$$\alpha(\omega) = \frac{|\mu_{ab}|^2}{\Delta E - \hbar\omega} + \frac{|\mu_{ab}|^2}{\Delta E + \hbar\omega} = 4.16666\dots$$

## Secular divergences

The Rayleigh–Schrödinger expression for the linear response function is:

$$\langle\langle\hat{\Omega}; \hat{V}^\omega\rangle\rangle = -\frac{1}{\hbar} \sum_n \left[ \frac{\langle 0|\hat{\Omega}|n\rangle\langle n|\hat{V}^\omega|0\rangle}{\omega_{n0} - \omega} + \frac{\langle 0|\hat{V}^\omega|n\rangle\langle n|\hat{\Omega}|0\rangle}{\omega_{n0} + \omega} \right]$$

This response function is not convergent as  $\omega \rightarrow 0$ , and the sum-over-states expression in this form cannot be used in the static limit.

Response functions free of secular divergencies are obtained with derivations based on phase-isolated wave functions.

## Overall permutation symmetry

The linear response can be compactly written as

$$\langle\langle \hat{\Omega}; \hat{V}^{\omega_1} \rangle\rangle = \sum \mathcal{P}_{-\sigma,1} \sum_{n>0} \frac{\langle 0 | \hat{\Omega} | n \rangle \langle n | \hat{V}^{\omega_1} | 0 \rangle}{\omega_{n0} - \omega_{\sigma}}$$

where  $\omega_{\sigma} = \omega_1$  is the sum of optical frequencies and  $\mathcal{P}_{-\sigma,1}$  permutes pairs of operators and frequencies:  $(-\omega_{\sigma}, \hat{\Omega})$  and  $(\omega_1, \hat{V}^{\omega_1})$ .

## Poles and residues

A residue analysis provides a means to obtain *excited state properties* from the ground state response function. The poles equal excitation energies and the residues are given by

$$\lim_{\omega_1 \rightarrow -\omega_{f0}} (\omega_{f0} - \omega_1) \langle\langle \hat{\Omega}; \hat{V}^{\omega_1} \rangle\rangle = \langle 0 | \hat{\Omega} | f \rangle \langle f | \hat{V}^{\omega_1} | 0 \rangle$$

## First-order nonlinear response functions

The first-order nonlinear response function comprises six terms:

$$\begin{aligned} \langle\langle \hat{\Omega}; \hat{V}^{\omega_1}, \hat{V}^{\omega_2} \rangle\rangle &= \frac{1}{\hbar^2} \sum \mathcal{P}_{1,2} \sum_{n,k>0} \\ &\times \left[ \frac{\langle 0 | \hat{\Omega} | n \rangle \langle n | \overline{\hat{V}^{\omega_1}} | k \rangle \langle k | \hat{V}^{\omega_2} | 0 \rangle}{[\omega_{n0} - (\omega_1 + \omega_2)][\omega_{k0} - \omega_2]} \right. \\ &+ \frac{\langle 0 | \hat{V}^{\omega_2} | n \rangle \langle n | \overline{\hat{V}^{\omega_1}} | k \rangle \langle k | \hat{\Omega} | 0 \rangle}{[\omega_{n0} + \omega_2][\omega_{k0} + (\omega_1 + \omega_2)]} \\ &\left. + \frac{\langle 0 | \hat{V}^{\omega_1} | n \rangle \langle n | \overline{\hat{\Omega}} | k \rangle \langle k | \hat{V}^{\omega_2} | 0 \rangle}{[\omega_{n0} + \omega_1][\omega_{k0} - \omega_2]} \right] \end{aligned}$$

where the overbar denotes a fluctuation operator in accordance with  $\overline{\hat{\Omega}} = \hat{\Omega} - \langle 0 | \hat{\Omega} | 0 \rangle$ .

## Overall permutation symmetry

The nonlinear response can be compactly written as

$$\begin{aligned} \langle\langle \hat{\Omega}; \hat{V}^{\omega_1}, \hat{V}^{\omega_2} \rangle\rangle &= \frac{1}{\hbar^2} \sum \mathcal{P}_{-\sigma,1,2} \\ &\times \sum_{n,k>0} \frac{\langle 0 | \hat{\Omega} | n \rangle \langle n | \overline{\hat{V}^{\omega_1}} | k \rangle \langle k | \hat{V}^{\omega_2} | 0 \rangle}{[\omega_{n0} - \omega_\sigma][\omega_{k0} - \omega_2]} \end{aligned}$$

where  $\omega_\sigma = \omega_1 + \omega_2$  is the sum of optical frequencies.

## Second-order residue

A residue analysis provides a means to obtain *excited state properties* from the ground state response function:

$$\begin{aligned} &\lim_{\omega_1 \rightarrow -\omega_{f0}} (\omega_{f0} + \omega_1) \left[ \lim_{\omega_2 \rightarrow \omega_{g0}} (\omega_{g0} - \omega_2) \langle\langle \hat{\Omega}; \hat{V}^{\omega_1}, \hat{V}^{\omega_2} \rangle\rangle \right] \\ &= \langle 0 | \hat{V}^{\omega_1} | f \rangle \langle f | \overline{\hat{\Omega}} | g \rangle \langle g | \hat{V}^{\omega_2} | 0 \rangle. \end{aligned}$$



# Excited state properties with Dalton2018

## Transition Moments

```
**DALTON INPUT
.RUN RESPONSE
**WAVE FUNCTION
.DFT
B3LYP
**RESPONSE
*LINEAR
.DIPLN
.SINGLE RESIDUE
.ROOTS
10
*END OF INPUT
```

## Excited State Dipole Moment

```
**DALTON INPUT
.RUN RESPONSE
**WAVE FUNCTION
.DFT
B3LYP
**RESPONSE
.PROPAVE
ZDIPLN
*QUADRATIC
.DIPLN
.DOUBLE RESIDUE
.ROOTS
10
*END OF INPUT
```

## Summary: perturbation theory expansions

- ▶ Response functions identified from perturbation theory expansions equal sum-over-states expressions
- ▶ In exact state theory, response function expressions are identical regardless of whether an Ehrenfest or quasi-energy approach is taken
- ▶ An understanding is provided as to how response properties depend on excitation energies and transition moments, which allows for rational material design
- ▶ With use of phase isolated wave functions, response functions are free of secular divergences
- ▶ From residue analyses of ground state response functions we are able to identify excited state properties
- ▶ A typical calculation of an excitation energy is made by finding a pole of the linear response function (polarizability) rather than an eigenvalue of the molecular Hamiltonian

# Resonant fields

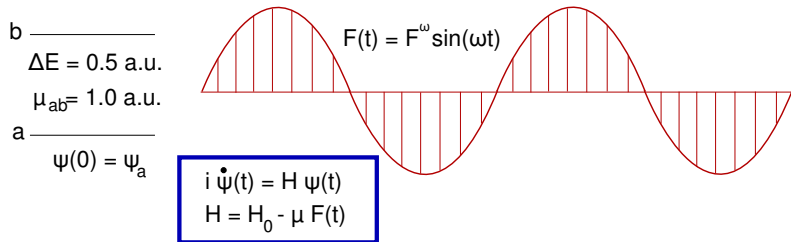

What happens if  $\hbar\omega = \Delta E$ ?

# Absorption

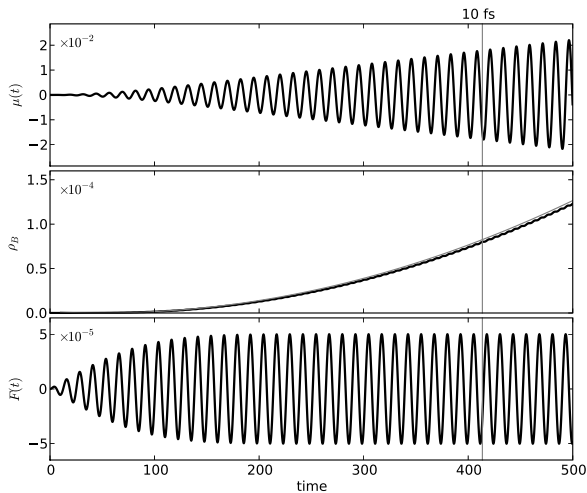

$$\rho_B(t) = \frac{1}{\hbar^2} |\langle f | \hat{V}^\omega | 0 \rangle F^\omega|^2 t^2$$

# Rabi Oscillations

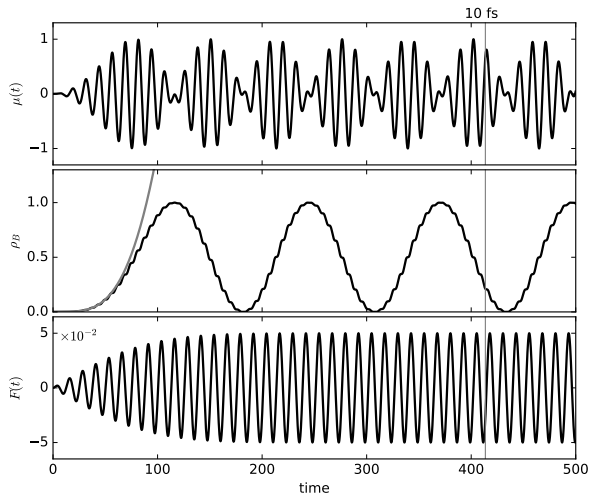

# Relaxation

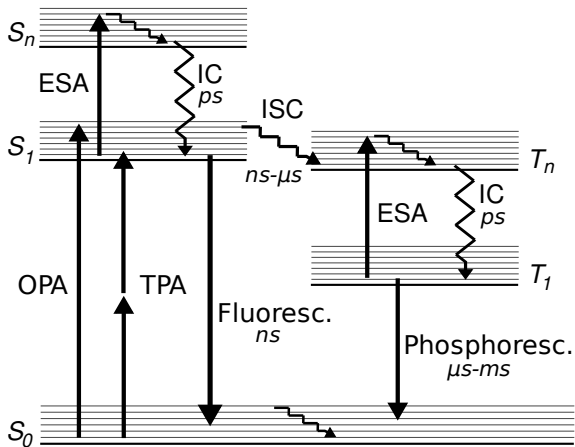

## Density matrix formalism

The density operator is defined as

$$\hat{\rho} = \sum_s p(s) |\psi_s(t)\rangle \langle \psi_s(t)|,$$

where the sum denoted a classical ensemble average. If all systems in the ensemble are identical then the summation contains a single term with unit probability.

With wave function expansions in the form of projections onto the eigenstates

$$|\psi_s(t)\rangle = \sum_n c_n^s(t) |n\rangle,$$

the matrix elements of the density operator becomes equal to

$$\rho_{mn} = \sum_s p(s) c_m^s c_n^{s*}.$$

## Coherence

An ensemble of systems with equal state populations, but for which the phases of the wave function components varies in an incoherent manner, will have vanishing elements  $\rho_{mn}$  ( $m \neq n$ ):

$$\rho = \frac{1}{2} \times \begin{pmatrix} 1 & 0 \\ 0 & 1 \end{pmatrix}.$$

An ensemble that can be described by a single wave function, on the other hand, is fully coherent and is said to be in *pure* state:

$$|\psi\rangle = \frac{1}{\sqrt{2}} \left( e^{i\phi_a} |\psi_a\rangle + e^{i\phi_b} |\psi_b\rangle \right)$$

with a density matrix:

$$\rho = \frac{1}{2} \times \begin{pmatrix} 1 & e^{i(\phi_a - \phi_b)} \\ e^{i(\phi_b - \phi_a)} & 1 \end{pmatrix}.$$



## Liouville equation with relaxation

$$\frac{\partial}{\partial t} \rho_{mn} = \frac{1}{i\hbar} [\hat{H}, \hat{\rho}]_{mn} - \gamma_{mn} (\rho_{mn} - \rho_{mn}^{\text{eq}})$$

The diagonal elements of the damping parameter matrix will govern the spontaneous population decays:

$$\tau_n = 1/\gamma_{nn}; \quad \Gamma_n = \gamma_{nn}, \quad n \neq 0; \quad \Gamma_0 = 0$$

we can, for a pure state, draw a conclusion that the off-diagonal elements of the density matrix will depend on time according to

$$|\rho_{mn}(t)| = |c_m(t)c_n^*(t)| = |c_m(0)c_n^*(0)|e^{-(\Gamma_m + \Gamma_n)t/2},$$

and we must therefore have

$$\gamma_{mn} = (\Gamma_m + \Gamma_n)/2.$$

# Time propagation of density matrix

$$\frac{\partial}{\partial t} \rho_{mn} = \frac{1}{i\hbar} [\hat{H}, \hat{\rho}]_{mn} - \gamma_{mn} (\rho_{mn} - \rho_{mn}^{\text{eq}})$$

## Initialization

```
H=array([[Ea, 0],
         [0, Eb]])
mu=array([[0, muab],
         [muba, 0]])
F=Fw*sin(w*t)*erf

rho_eq=array([[1,0],
             [0,0]])
rho[:, :, 0]=[[1,0],
              [0,0]]
```

## Time Propagation

```
for k in range(1,n):
    rho[:, :, k] = rho[:, :, k-1] -
        delta*1.0j*(
            dot(H - mu*F[k-1], rho[:, :, k-1]) -
            dot(rho[:, :, k-1], H - mu*F[k-1])
        ) -
        delta*gamma*(rho[:, :, k-1]-rho_eq)

    P[k] = dot(rho[:, :, k], mu).trace()

popa=rho[0,0,:]
popb=rho[1,1,:]
```

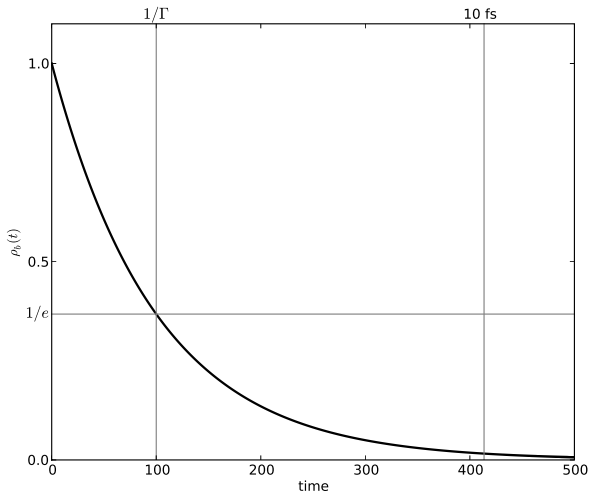

$$\rho(0) = \begin{pmatrix} 0 & 0 \\ 0 & 1 \end{pmatrix}; \quad \rho^{\text{eq}} = \begin{pmatrix} 1 & 0 \\ 0 & 0 \end{pmatrix}; \quad \gamma = \Gamma \times \begin{pmatrix} 1 & 1/2 \\ 1/2 & 1 \end{pmatrix}$$

# Induced polarization in two-level atom (resonant field, relaxation)

$$\Gamma = 0.025 \text{ a.u.}$$

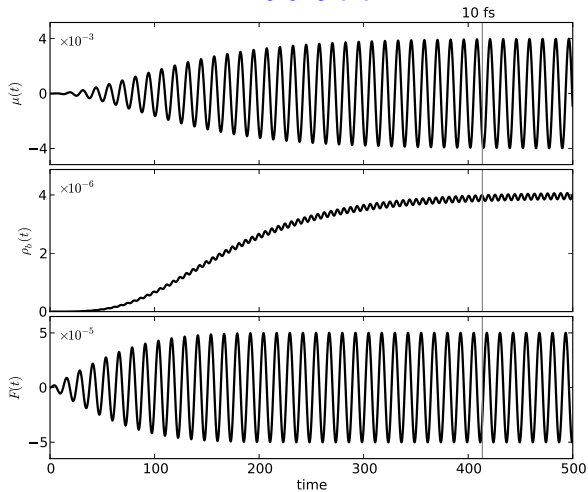

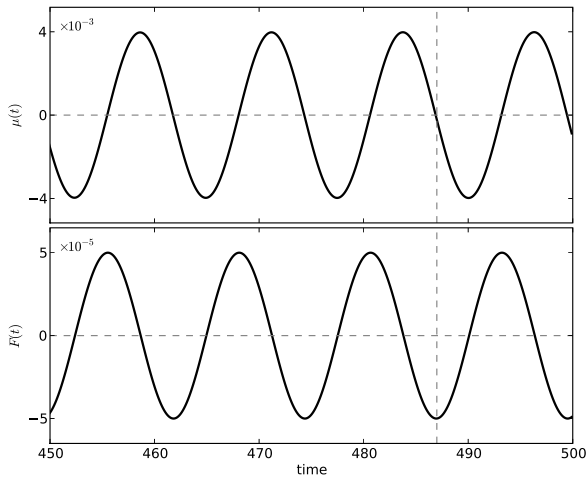

$$\alpha = i \frac{\max[\mu(t)]}{F\omega} \approx 80i \text{ a.u.}$$

## Relaxation in wave function theory

Apply the Ehrenfest theorem to  $\hat{\Omega} = |n\rangle\langle m|$ :

$$\frac{\partial}{\partial t} \langle m|\psi(t)\rangle\langle\psi(t)|n\rangle = \frac{1}{i\hbar} \left[ \langle m|\hat{H}|\psi(t)\rangle\langle\psi(t)|n\rangle - \langle m|\psi(t)\rangle\langle\psi(t)|\hat{H}|n\rangle \right]$$

The above equation is thus a mere repetition of the Liouville equation for density matrix element  $\rho_{mn}$ , and a suitable equation-of-motion with relaxation in wave function theory is

$$\frac{\partial}{\partial t} \langle\psi|\hat{\Omega}|\psi\rangle = \frac{1}{i\hbar} \langle\psi|[\hat{\Omega}, \hat{H}]|\psi\rangle - \gamma_{mn} \left[ \langle\psi|\hat{\Omega}|\psi\rangle - \langle\psi^{\text{eq}}|\hat{\Omega}|\psi^{\text{eq}}\rangle \right]$$

This formulation of response theory is known as the complex polarization propagator (CPP) approach and it has been implemented up to cubic response functions.

# Linear response functions

Molecular spectroscopies are interpreted as responses to electromagnetic fields or geometric perturbations. The linear responses of a molecular property to a perturbation are given by

$$\langle\langle \hat{A}; \hat{V} \rangle\rangle_{\omega} = -\frac{1}{\hbar} \sum_{n>0} \left[ \frac{\langle 0 | \hat{A} | n \rangle \langle n | \hat{V} | 0 \rangle}{\omega_n - \omega - i\gamma_{n0}} + \frac{\langle 0 | \hat{V} | n \rangle \langle n | \hat{A} | 0 \rangle}{\omega_n + \omega + i\gamma_{n0}} \right]$$

## Spectroscopies and linear response functions

UV/vis absorption

$\text{Im} \langle\langle \hat{\mu}; \hat{\mu} \rangle\rangle_{\omega}$

Refractive index

$\text{Re} \langle\langle \hat{\mu}; \hat{\mu} \rangle\rangle_{\omega}$

Optical rotation

$\text{Im} \langle\langle \hat{\mu}; \hat{m} \rangle\rangle_{\omega}$

Electronic circular dichroism

$\text{Re} \langle\langle \hat{\mu}; \hat{m} \rangle\rangle_{\omega}$

And more ...

...

# Complex Polarizability

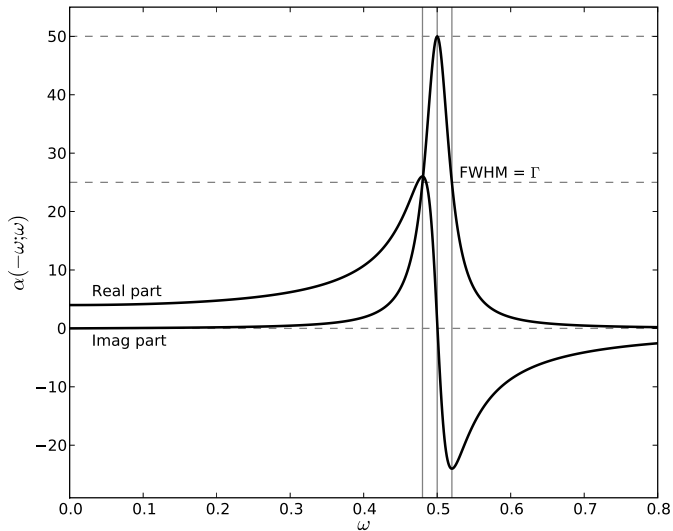



## Pole structure

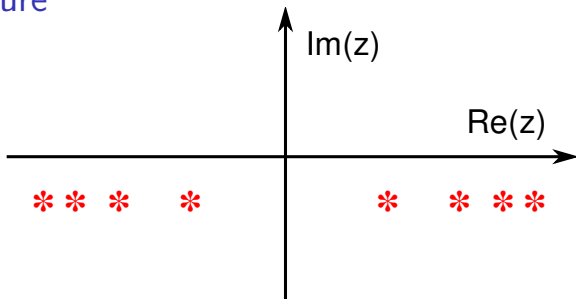

$$\langle\langle \hat{A}; \hat{V} \rangle\rangle_z = -\frac{1}{\hbar} \sum_{n>0} \left[ \frac{\langle 0 | \hat{A} | n \rangle \langle n | \hat{V} | 0 \rangle}{\omega_n - z - i\gamma_n} + \frac{\langle 0 | \hat{V} | n \rangle \langle n | \hat{A} | 0 \rangle}{\omega_n + z + i\gamma_n} \right]$$

- ▶ Linear response function is convergent and physically sound for all real frequencies (but will be complex).
- ▶ No poles in the upper half plane is a characteristic required for causal propagators.

## Two-level atom: response function value

Observable:  $\hat{\Omega} = \hat{\mu}$

Perturbation:  $\hat{V}^\omega = -\hat{\mu}$

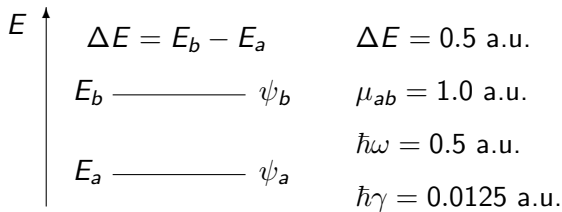

$$\alpha(\omega) = \frac{|\mu_{ab}|^2}{\Delta E - \hbar\omega - i\hbar\gamma} + \frac{|\mu_{ab}|^2}{\Delta E + \hbar\omega + i\hbar\gamma} \approx \frac{|\mu_{ab}|^2}{-i\hbar\gamma} = 80i$$

# Summary

- ▶ Molecular properties are defined by expansions of energy, quasi-energy, polarization, magnetization, etc. in orders of field amplitudes.
- ▶ The diagonal elements of the electronic Hessian contains excitation energies.
- ▶ Use of explicitly unitary parameterizations embeds the requirement of conserving the norm of the wave function.
- ▶ Use of phase-isolated wave functions in expansions yields response functions that are free of secular divergences.
- ▶ The first variation in the time-averaged quasi-energy is zero, in accordance with the first variation of the energy in the time-independent case.
- ▶ The time-dependent Hellmann–Feynman theorem connects the quasi-energy with molecular properties.
- ▶ Nonresonant response functions are overall symmetric.
- ▶ Poles and residues of response functions are connected to excited state properties.
- ▶ With spontaneous relaxation, excited state populations may remain small under resonance conditions. The corresponding response functions become complex.